

## 16/20A & 30/32A receptacles, plugs, connectors & inlets

### 16/20A & 30/32A receptacles

Family	A	B	C	D	E	F	G	H	I	J	K	L	M
<b>16/20A</b>	3.125"	0.21"	3.125"	2.98"	3.75"	3.75"	0.315"	3.15"	2.15"	1.25"	2.74"	2.74"	1.69"
<b>2-P, 3-W</b>	(7.94cm)	(0.54cm)	(7.94cm)	(7.57cm)	(9.52cm)	(9.52cm)	(.8cm)	(8cm)	(5.47cm)	(3.18cm)	(6.96cm)	(6.96cm)	(4.29cm)
<b>16/20A</b>	3.125"	0.21"	3.125"	3.28"	3.75"	3.75"	0.315"	3.38"	2.18"	1.25"	2.74"	2.74"	2.01"
<b>3-P, 4-W</b>	(7.94cm)	(0.54cm)	(7.94cm)	(8.33cm)	(9.52cm)	(9.52cm)	(.8cm)	(8.58cm)	(5.54cm)	(3.18cm)	(6.96cm)	(6.96cm)	(5.12cm)
<b>16/20A</b>	3.125"	0.21"	3.125"	3.66"	3.75"	3.75"	0.315"	3.66"	2.27"	1.25"	2.74"	2.74"	2.09"
<b>4-P, 5-W</b>	(7.94cm)	(0.54cm)	(7.94cm)	(9.3cm)	(9.52cm)	(9.52cm)	(.8cm)	(9.3cm)	(5.77cm)	(3.18cm)	(6.96cm)	(6.96cm)	(5.3cm)
<b>30/32A</b>	3.125"	0.21"	3.125"	3.97"	3.75"	3.75"	0.315"	3.91"	2.64"	1.57"	2.74"	2.74"	2.24"
<b>2-P, 3-W</b>	(7.94cm)	(0.54cm)	(7.94cm)	(10cm)	(9.52cm)	(9.52cm)	(.8cm)	(9.92cm)	(6.7cm)	(4.0cm)	(6.96cm)	(6.96cm)	(5.69cm)
<b>&amp; 3-P, 4-W</b>													
<b>30/32A</b>	3.125"	0.21"	3.125"	4.22"	3.75"	3.75"	0.315"	4.13"	2.64"	1.57"	2.74"	2.74"	2.47"
<b>4-P, 5-W</b>	(7.94cm)	(0.54cm)	(7.94cm)	(10.7cm)	(9.52cm)	(9.52cm)	(.8cm)	(10.5cm)	(6.7cm)	(4.0cm)	(6.96cm)	(6.96cm)	(6.27cm)

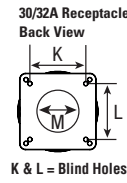
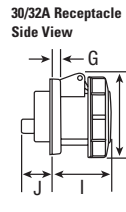
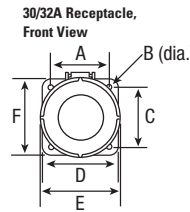
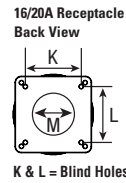
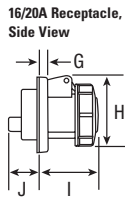
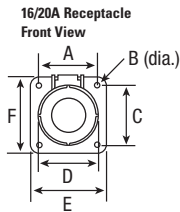

### 16/20A & 30/32A plugs

Family	A	B	C	D (cord dia.)	Threaded entry (NPT)
<b>16/20A</b>	6.08"	4.65"	2.98"	0.333-0.775"	0.75" (1.91cm)
<b>2-P, 3-W</b>	(15.44cm)	(11.8cm)	(7.57cm)	(0.85-1.97cm)	
<b>16/20A</b>	6.14"	4.70"	3.28"	0.333-0.775"	0.75" (1.91cm)
<b>3-P, 4-W</b>	(15.6cm)	(11.94cm)	(8.33cm)	(0.85-1.97cm)	
<b>16/20A</b>	6.24"	4.81"	4.18"	0.433-0.84"	1.0" (2.54cm)
<b>4-P, 5-W</b>	(15.85cm)	(12.22cm)	(10.6cm)	(1.10-2.13cm)	
<b>30/32A</b>	7.32"	5.53"	3.85"	0.433-0.985"	1.0" (2.54cm)
<b>2-P, 3-W &amp; 3-P, 4-W</b>	(18.6cm)	(14.05cm)	(9.78cm)	(1.10-2.5cm)	
<b>30/32A</b>	7.46"	5.67"	4.17"	0.433-1.15"	1.25" (3.18cm)
<b>4-P, 5-W</b>	(18.95cm)	(14.4cm)	(10.6cm)	(1.10-2.92cm)	

16/20A & 30/32A Plugs, Side View

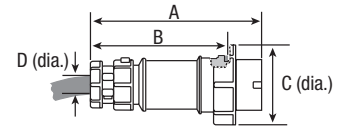

### 16/20A & 30/32A connectors

Family	A	B	C (cord dia.)	D	Threaded entry (NPT)
<b>16/20A</b>	6.91"	2.98"	0.333-0.775"	3.13"	0.75" (1.91cm)
<b>2-P, 3-W</b>	(17.56cm)	(7.57cm)	(0.85-1.97cm)	(7.96cm)	
<b>16/20A</b>	6.89"	3.28"	0.333-0.775"	3.37"	0.75" (1.91cm)
<b>3-P, 4-W</b>	(17.49cm)	(8.33cm)	(0.85-1.97cm)	(8.56cm)	
<b>16/20A</b>	7.19"	3.66"	0.433-0.84"	3.66"	1.0" (2.54cm)
<b>4-P, 5-W</b>	(18.27cm)	(8.33cm)	(1.10-2.13cm)	(9.3cm)	
<b>30/32A</b>	8.55"	3.97"	0.433-0.985"	3.89"	1.0" (2.54cm)
<b>2-P, 3-W &amp; 3-P, 4-W</b>	(22.72cm)	(10.1cm)	(1.10-2.5cm)	(9.89cm)	
<b>30/32A</b>	8.74"	4.22"	0.433-1.15"	4.13"	1.25" (3.18cm)
<b>4-P, 5-W</b>	(22.19cm)	(10.7cm)	(1.10-2.92cm)	(10.49cm)	

16/20A & 30/32A Connectors Underside View

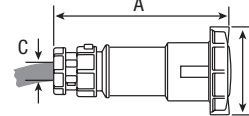

16/20A & 30/32A Connectors, Side View

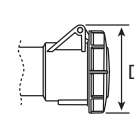

### 16/20A & 30/32A inlets

Family	A	B	C	D	E	F	G	H	I	J	K
<b>16/20A</b>	3.125"	0.21"	3.125"	3.75"	3.75"	0.315"	2.76"	2.75"	2.74"	2.74"	1.52"
<b>2-P, 3-W</b>	(7.94cm)	(0.54cm)	(7.94cm)	(9.52cm)	(9.52cm)	(0.8cm)	(7cm)	(6.99cm)	(6.96cm)	(6.96cm)	(3.86cm)
<b>16/20A</b>	3.125"	0.21"	3.125"	3.75"	3.75"	0.315"	3.06"	2.75"	2.74"	2.74"	1.74"
<b>3-P, 4-W</b>	(7.94cm)	(0.54cm)	(7.94cm)	(9.52cm)	(9.52cm)	(0.8cm)	(7.77cm)	(6.99cm)	(6.96cm)	(6.96cm)	(4.42cm)
<b>16/20A</b>	3.125"	0.21"	3.125"	3.75"	3.75"	0.315"	3.45"	2.75"	2.74"	2.74"	1.96"
<b>4-P, 5-W</b>	(7.94cm)	(0.54cm)	(7.94cm)	(9.52cm)	(9.52cm)	(0.8cm)	(8.76cm)	(6.99cm)	(6.96cm)	(6.96cm)	(4.98cm)
<b>30/32A</b>	3.125"	0.21"	3.125"	3.75"	3.75"	0.315"	3.68"	3.4"	2.74"	2.74"	2.0"
<b>2-P, 3-W &amp; 3-P, 4-W</b>	(7.94cm)	(0.54cm)	(7.94cm)	(9.52cm)	(9.52cm)	(0.8cm)	(9.35cm)	(8.64cm)	(6.96cm)	(6.96cm)	(5.08cm)
<b>30/32A</b>	3.125"	0.21"	3.125"	3.75"	3.75"	0.315"	3.94"	3.4"	2.74"	2.74"	2.22"
<b>4-P, 5-W</b>	(7.94cm)	(0.54cm)	(7.94cm)	(9.52cm)	(9.52cm)	(0.8cm)	(10cm)	(8.64cm)	(6.96cm)	(6.96cm)	(5.64cm)

16/20A & 30/32A Inlets, Front View

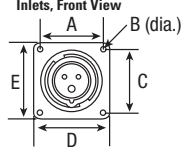

16/20A & 30/32A Inlets, Side View

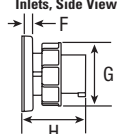

16/20A & 30/32A Inlets, Back View

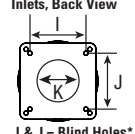

\*Blind holes can be drilled out to mount to previous versions of Arrow Hart back boxes.  
Compliances, specifications and availability are subject to change without notice.

## 60/63A & 100/125A receptacles, plugs, connectors & inlets

### 60/63A & 100/125A receptacles

Family	A	B	C	D	E	F	G	H	I	J	K	L	M	N
<b>60/63A</b>	3.88" (9.8cm)	0.21" (0.54cm)	3.88" (9.8cm)	4.5" (11.4cm)	4.6" (11.7cm)	4.5" (11.4cm)	0.079" (0.2cm)	4.42" (11.2cm)	3.02" (7.68cm)	2.3" (5.8cm)	0.39" (1cm)	3.03" (7.70cm)	3.35" (8.51cm)	3.35" (8.5cm)
<b>100/125A</b>	4.87" (12.4cm)	0.21" (0.54cm)	4.87" (12.4cm)	5.5" (14cm)	5.1" (13cm)	5.5" (14cm)	0.12" (0.3cm)	4.86" (12.3cm)	4.20" (10.7cm)	1.93" (4.9cm)	0.47" (1.2cm)	4.10" (10.4cm)	4.10" (10.4cm)	4.57" (11.6cm)
<b>60A angled</b>	3.88" (9.8cm)	0.21" (0.54cm)	3.88" (9.8cm)	4.6" (11.7cm)	4.7" (11.9cm)	4.7" (11.9cm)	0.079" (0.2cm)		3.23" (8.2cm)	2.3" (5.8cm)	0.37" (1.1cm)	3.03" (7.70cm)	3.35" (8.51cm)	3.35" (8.5cm)
<b>100A angled</b>	4.87" (12.4cm)	0.21" (0.54cm)	4.87" (12.4cm)	5.5" (14cm)	5.5" (14cm)	5.5" (14cm)	0.12" (0.3cm)		3.5" (8.9cm)	2.05" (5.2cm)	0.43" (1.09cm)	3.54" (8.9cm)	3.54" (8.9cm)	4.57" (11.6cm)

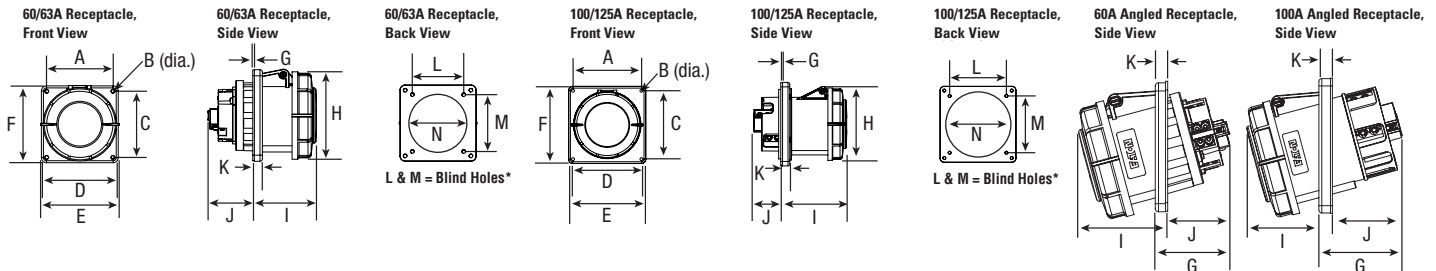

### 60/63A & 100/125A plugs

Family	A	B	C (cord dia.)	Threaded entry (NPT)
<b>60/63A</b>	9.26" (23.52cm)	4.45" (11.29cm)	0.66-1.50" (1.68-3.81cm)	1.5" (3.81cm)
<b>100/125A</b>	11.16" (28.35cm)	5.17" (13.14cm)	0.97-1.94" (2.46-5.00cm)	2.0" (5.08cm)

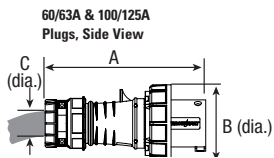

### 60/63A & 100/125A connectors

Family	A	B	C (cord dia.)	D	Threaded entry (NPT)
<b>60/63A</b>	10" (25.39cm)	4.29" (10.9cm)	0.66-1.5" (1.68-3.81cm)	4.43" (11.25cm)	1.5" (3.81cm)
<b>100/125A</b>	11.83" (30.04cm)	4.76" (12.1cm)	0.97-1.94" (2.46-4.93cm)	4.86" (12.34cm)	2.0" (5.08cm)

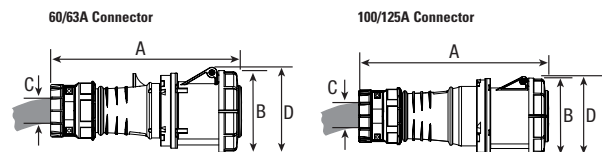

### 60/63A & 100/125A inlets

Family	A	B	C	D	E	F	G	H	I	J	K	L	M	N
<b>60/63A</b>	3.875" (9.84cm)	0.21" (0.54cm)	3.88" (9.84cm)	4.5" (11.4cm)	4.5" (11.4cm)	0.39" (1cm)	4.45" (11.30cm)	3.25" (8.26cm)	1.52" (3.87cm)	3.88" (9.84cm)	3.88" (9.84cm)	2.88" (7.32cm)	3.54" (8.99cm)	3.54" (8.99cm)
<b>100/125A</b>	4.87" (12.4cm)	0.21" (0.54cm)	4.87" (12.4cm)	5.5" (14cm)	5.5" (14cm)	0.47" (1.2cm)	5.17" (13.1cm)	4" (10.2cm)	1.38" (3.51cm)	4.87" (12.4cm)	4.87" (12.4cm)	3.66" (9.3cm)	4.10" (10.41cm)	4.10" (10.41cm)

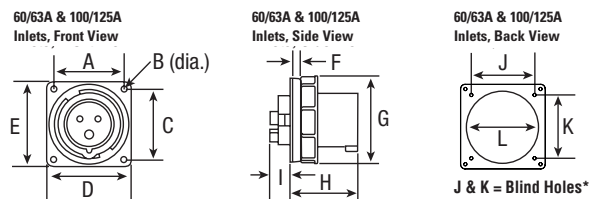

Compliances, specifications and availability are subject to change without notice.

Back boxes, feed through & mechanical interlocks

20/23A, 30/32A, 60/63A, 100/125A back boxes

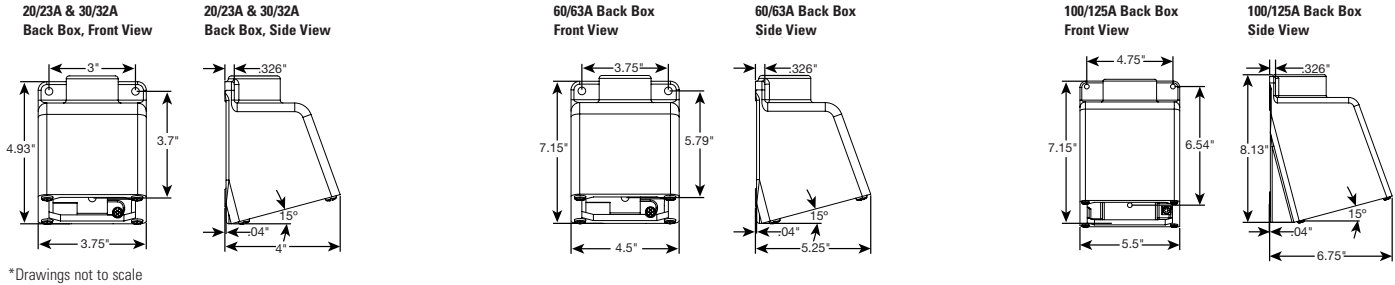

20/23A & 30/32A feed through

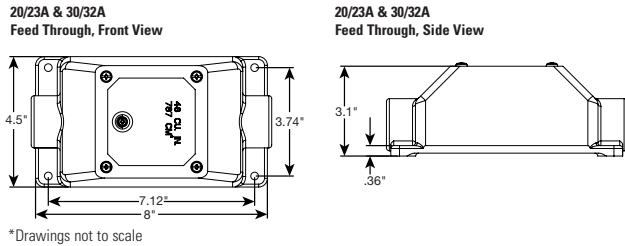

Mounting holes for back boxes & feed through

Family	A	B
16/20A & 30/32A	3.125" (79.4mm)	3.125" (79.4mm)
60/63A	3.875" (98.4mm)	3.875" (98.4mm)
100/125A	4.870" (123.7mm)	4.870" (123.7mm)
Feed through	3.125" (79.4mm)	3.125" (79.4mm)

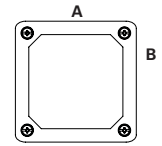

#10-32 Tapped holes

20A non-fusible mechanical interlocks

Family	A	B	C	D	E	F	G
20A	6.70"	5.35"	0.24"	5.35"	0.24"	4.65"	4.10"
2-P, 3-W	(17.02cm)	(13.59cm)	(0.61cm)	(13.59cm)	(0.61cm)	(11.81cm)	(10.41cm)
20A	6.70"	5.35"	0.24"	5.47"	0.24"	4.65"	4.10"
3-P, 4-W	(17.02cm)	(13.59cm)	(0.61cm)	(13.89cm)	(0.61cm)	(11.81cm)	(10.41cm)
20A	6.70"	5.35"	0.24"	5.63"	0.24"	4.65"	4.10"
4-P, 5-W	(17.02cm)	(13.59cm)	(0.61cm)	(14.30cm)	(0.61cm)	(11.81cm)	(10.41cm)

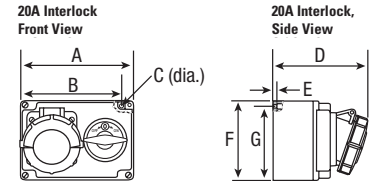

20A fuse or circuit breaker option mechanical interlocks

Family	A	B	C	D	E	F	G	H
20A	4.59"	14.33"	5.28"	0.32"	15.37"	6.12"	13.66"	0.25"
3-P, 4-W	(11.66cm)	(36.40cm)	(13.41cm)	(0.81cm)	(39.04cm)	(15.54cm)	(34.70cm)	(0.64cm)

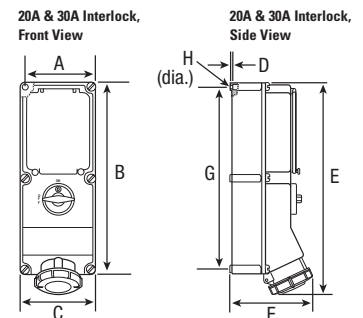

# Dimensional information



## Non-fusible & fusible, fuse or circuit breaker option mechanical interlocks

### 30A non-fusible & fusible mechanical interlocks

Family	A	B	C	D	E	Hub size
30A	6.56"	10.30"	6.69"	12.00"	6.44"	1"
2-P, 3-W	(16.66cm)	(26.16cm)	(16.99cm)	(30.48cm)	(16.36cm)	(2.54cm)
30A	6.56"	10.30"	6.69"	12.00"	6.44"	1"
3-P, 4-W	(16.66cm)	(26.16cm)	(16.99cm)	(30.48cm)	(16.36cm)	(2.54cm)
30A	6.56"	10.30"	6.69"	12.00"	6.44"	1"
4-P, 5-W	(16.66cm)	(26.16cm)	(16.99cm)	(30.48cm)	(16.36cm)	(2.54cm)

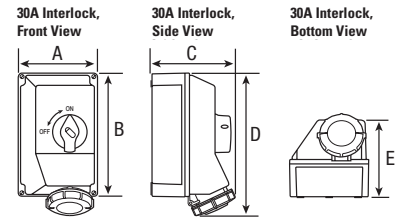

### 30A fuse or circuit breaker option mechanical interlocks

Family	A	B	C	D	E	F	G	H
30A	4.59"	14.33"	5.28"	0.32"	15.37"	6.12"	13.66"	0.25"
3-P, 4-W	(11.66cm)	(36.40cm)	(13.41cm)	(0.81cm)	(39.04cm)	(15.54cm)	(34.70cm)	(0.64cm)
30A	4.59"	14.33"	5.28"	0.32"	15.37"	6.12"	13.66"	0.25"
4-P, 5-W	(11.66cm)	(36.40cm)	(13.41cm)	(0.81cm)	(39.04cm)	(15.54cm)	(34.70cm)	(0.64cm)

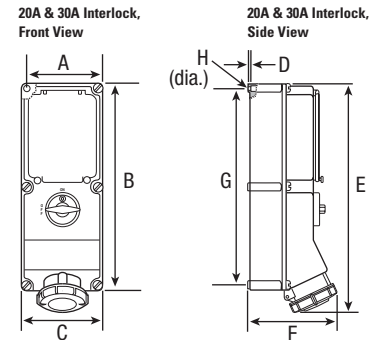

### 60A non-fusible & fusible mechanical interlocks

Family	A	B	C	D	E	Hub size
60A	7.00"	13.00"	9.25"	14.62"	8.38"	1 1/4"
2-P, 3-W	(17.78cm)	(33.02cm)	(23.50cm)	(37.13cm)	(21.18cm)	(3.18cm)
60A	7.00"	13.00"	9.25"	14.62"	8.38"	1 1/4"
3-P, 4-W	(17.78cm)	(33.02cm)	(23.50cm)	(37.13cm)	(21.18cm)	(3.18cm)
60A	7.00"	13.00"	9.25"	14.62"	8.38"	1 1/4"
4-P, 5-W	(17.78cm)	(33.02cm)	(23.50cm)	(37.13cm)	(21.18cm)	(3.18cm)

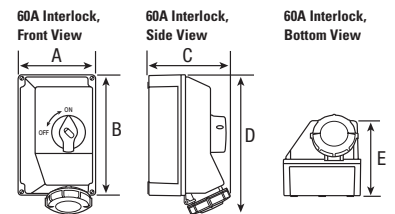

### 60A fuse or circuit breaker option mechanical interlocks

Family	A	B	C	D	E	F	G	H
60A	6.25"	18.11"	7.09"	0.32"	19.56"	7.56"	17.32"	0.32"
3-P, 4-W	(15.88cm)	(46.00cm)	(18.01cm)	(0.81cm)	(49.68cm)	(19.20cm)	(43.99cm)	(0.81cm)
60A	6.25"	18.11"	7.09"	0.32"	19.56"	7.56"	17.32"	0.32"
4-P, 5-W	(15.88cm)	(46.00cm)	(18.01cm)	(0.81cm)	(49.68cm)	(19.20cm)	(43.99cm)	(0.81cm)

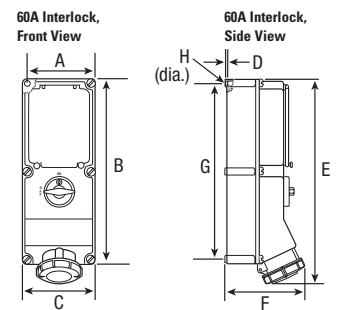

### 100A non-fusible mechanical interlocks

Family	A	B	C	D	E	F	G	H
100A	10.25"	18.13"	9.25"	17.06"	0.38"	20.69"	11.13"	0.24"
2-P, 3-W	(26.04cm)	(46.05cm)	(23.50cm)	(43.33cm)	(0.97cm)	(52.55cm)	(28.27cm)	(0.61cm)
100A	10.25"	18.13"	9.25"	17.06"	0.38"	20.69"	11.13"	0.24"
3-P, 4-W	(26.04cm)	(46.05cm)	(23.50cm)	(43.33cm)	(0.97cm)	(52.55cm)	(28.27cm)	(0.61cm)
100A	10.25"	18.13"	9.25"	17.06"	0.38"	20.69"	11.13"	0.24"
4-P, 5-W	(26.04cm)	(46.05cm)	(23.50cm)	(43.33cm)	(0.97cm)	(52.55cm)	(28.27cm)	(0.61cm)

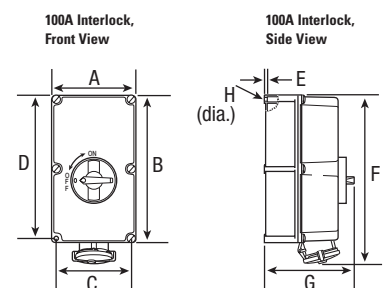

Compliances, specifications and availability are subject to change without notice.